



Refrigeration Compressor

QD43HB

110V/1Ph/50Hz
R134A

Compressor Technical Specifications

INDEX

- 1. Compressor Type.....
- 2. Performance Data.....
- 3. Running Condition.....
- 4. Compressor Mechanical Information.....
- 5. Residue.....
- 6. Compressor Shape
- 7. Wiring Diagram.....
- 8. Starter and Protector.....
- 9. Starter and Protector Appearance.....
- 10. Delivery List.....
- 11. Package, Storage and Transportation.....
- 12. Accessory Diagram.....
- 13. General Requirement.....
- 14. Environmental Protection Requirement to Compressor and Accessories.....

1. Compressor Type

Compressor Model	QD43HB
Rated Voltage/Frequency	110V/50Hz
Refrigerant	R134a
Application	L/MBP
Cooling Type	Static Cooling
Throttle Device	Capillary
Start Torque	High Starting Torque
Motor Type	CSIR
Running Capacitor	Yes (280 μ F/250V)

2. Technology Parameter

Displacement	Nominal Power	Technology Parameter				
		Frequency (Hz)	Cooling Capacity $\geq 95\%$ (W)	Input Power $\leq 115\%$ (W)	Current $\leq 110\%$ (A)	COP $\geq 95\%$ (W/W)
4.3 Cm ³	1/8 HP	50 Hz	110	84	1.5	1.31

Testing Conditions	LBP
	ASHAE
Evaporating Temperature	-23.3°C / -9.94°F
Ambient Temperature	32.2°C / 89.96°F
Condensing Temperature	54.4°C / 129.92°F
Suction Temperature	32.2°C / 89.96°F
Subcooling Temperature	32.2°C / 89.96°F

3. Running Condition

Ambient Temperature	10~43°C / 50~109.4°F
Evaporating Temperature	-35~0°C / -31~32°F
Voltage Range	98-135V
Max. Discharge Pressure	1.86Mpa (abs)
Max. Condensing Temperature	65°C / 149°F
Max. Winding Temperature	120°C / 248°F
Max. Shell Temperature	95°C / 203°F
Max. Discharge Temperature	110°C / 230°F
Starting Performance	85V [0.5Mpa]
Shell Min. Resistance to Pressure	25bar

4. Compressor Mechanical Information

Oil Type	Ester Oil
Viscosity of Refrigerant Oil	30-34mm ² /S (40°C/104°F)
Density of Refrigerant Oil	0.975-0.981g/ml (20°C/68°F)
Brand	RL32H
Oil Changing Volume	180±5ml
Weight (Including Oil)	6.5kg
Diameter of Suction Tube (I.D)	Φ6.3±0.5mm
Diameter of Discharge Tube (I.D)	Φ5.2±0.5mm
Diameter of Process Tube (I.D) (P)	Φ6.3±0.5mm
Material of Suction Tube, Process Tube and Discharge Tube	TP2
Compressor Noise	≤39dB(A) (GB/T9098-2008)
Vibration	0.3m/s ²
Protecting Gas	Dry Nitrogen 0.03 ~0.05 Mpa (dewpoint: -60°C/-76°F)
Height	171mm
Water Collector Hook	No
Sealing	Rubber Plug

5. Residue

Moisture Content	≤80mg
Content of Residual Impurities	≤50mg

6. Compressor Shape

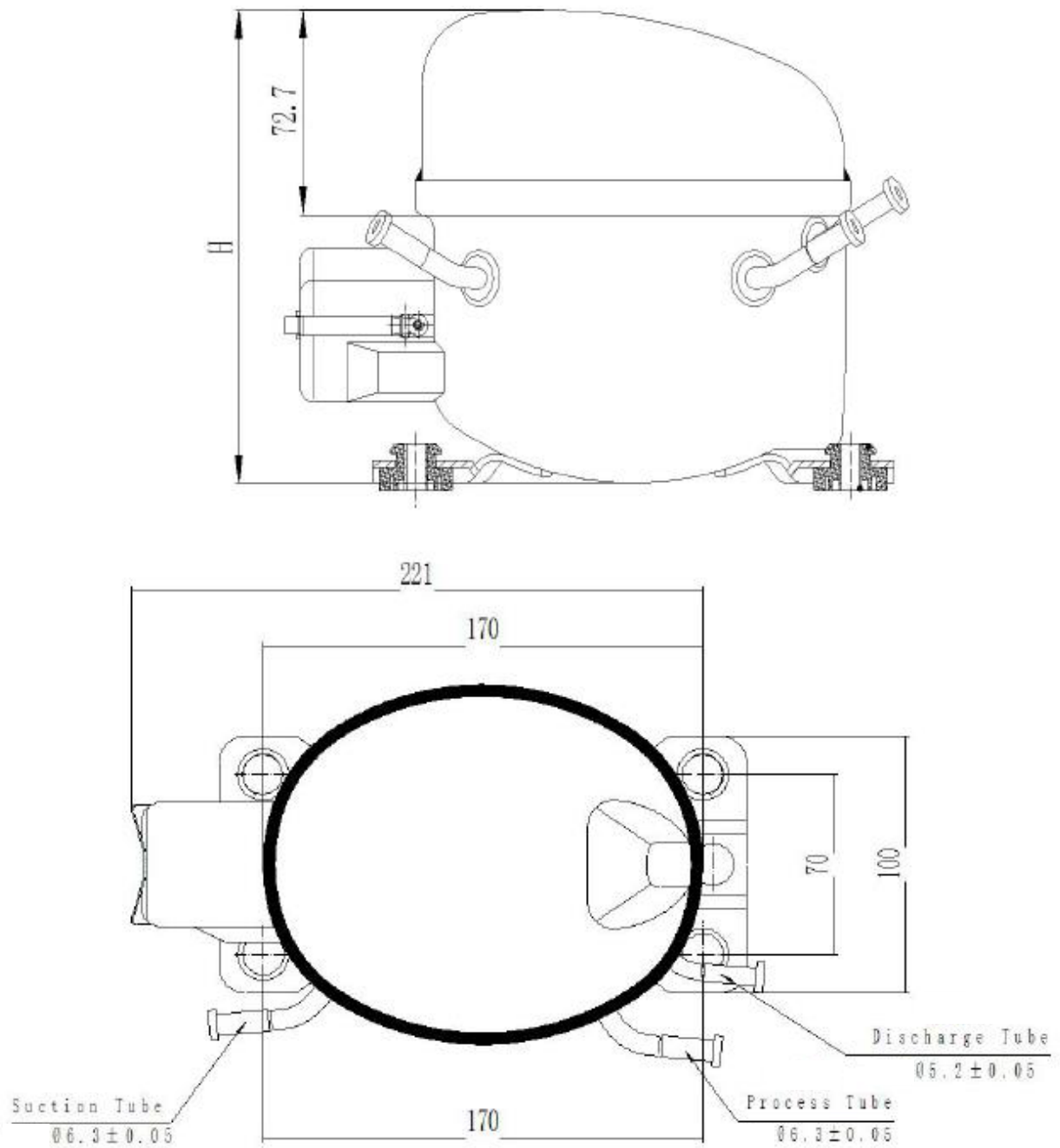

7. Wiring Diagram

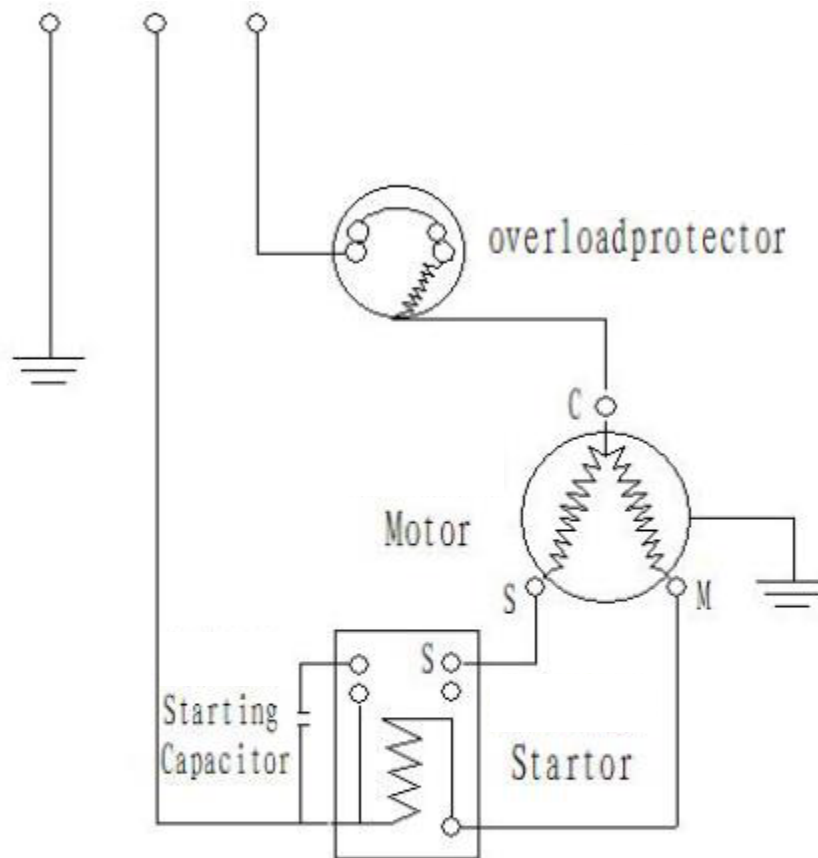

CSIR (CURRENT)

8. Starter and Protector

8.1 Starter

Model: QL2-3.80

Starter Type: CURRENT

Manufacturers: Hangzhou Huo Furman Electrical Appliance Co. Ltd.

8.2 Protector

Model: BB90-135

Manufacturers Hangzhou Huo Furman Electrical Appliance Co. Ltd.

Compressor Model	QD43HB
Trip Current (25°C/77°F)	9.0A
Trip Time	7-14S
Reset Time	45-120S
Trip Temperature	135±5°C
Reset Temperature	61±9°C
The Minimum Trip Current (75°C/167°F)	2.2A
Assembly Force	≤75N
Disassembly Force	≥9N
UL Flammability Classification	UL94V-0

9. Starter and Protector Appearance

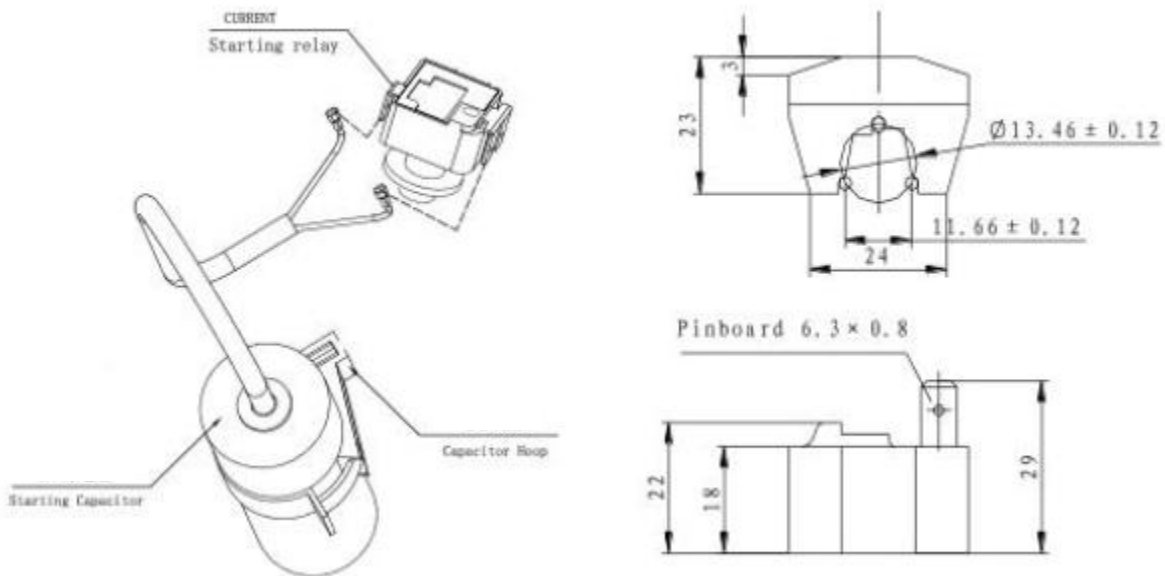

Note:

- 1) All electrical parts and installation accessories are packed separately, not installed on the compressor.
- 2) All electrical parts and installation accessories listed on the delivery list are all provided by our company.

10. Delivery List

Serial Number	Name	Specifications	Quantity (pc)
1	Compressor	QD43HB	1
2	Installation Accessories		
2.1	Rubber Grommet		4
2.2	Sleeve		4
3	Electrical Accessories		
3.1	Thermal Overload Protector		1
3.2	Current Starter		1
3.3	Relay Cover		1
3.4	Cover Buckle		1
3.5	Grounding Screw (Including Washers)	M4×6	1
3.6	Start Capacitor	280μF/250V	1

11. Package, Storage and Transportation

Quantity	100/120 pcs/pallet
Stacking Layer	At most two layers
Main Packing Components	Wooden supporter, upper wooden cover, carton
Transfer	Keep the compressor in normal and vertical position

12. Accessory Diagram as Bellow

1) Rubber grommet:

Material	Natural rubber
Hardness	Shore A55±5°
Color	Black

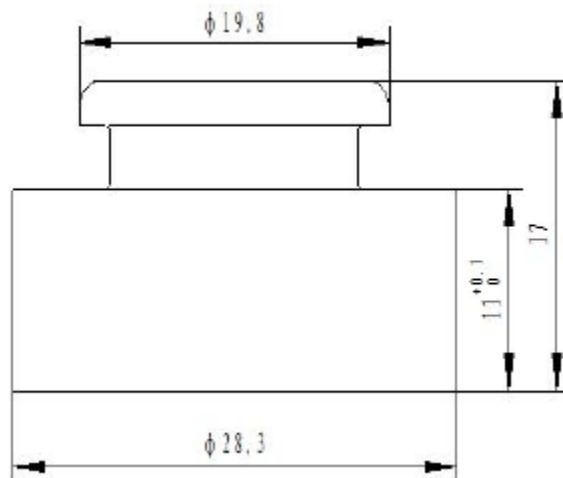

2) Sleeve:

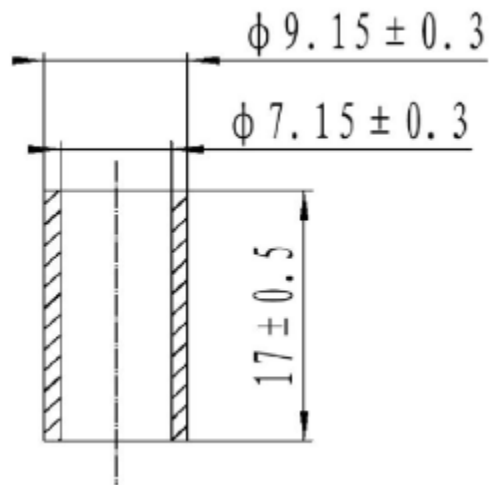

3) Relay cover:

Material	PPO
UL Flammability Classification	UL94V-0

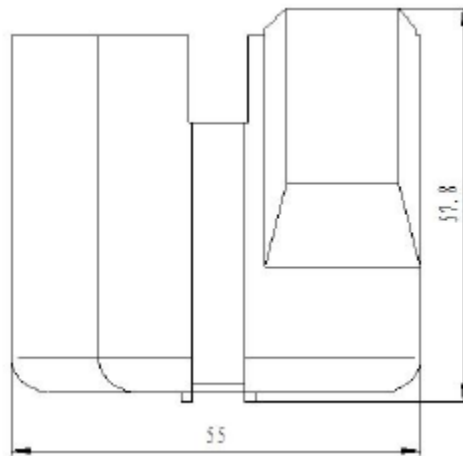

4) Grounding Screw:

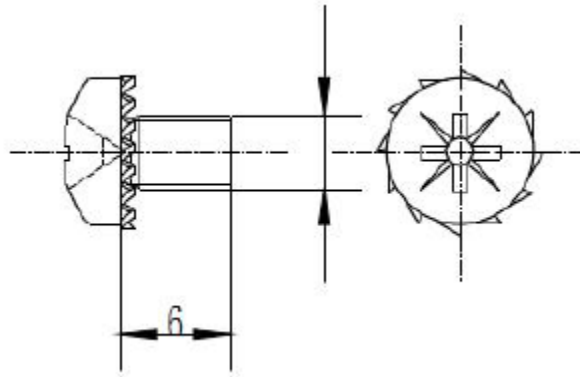

5) Cover Card:

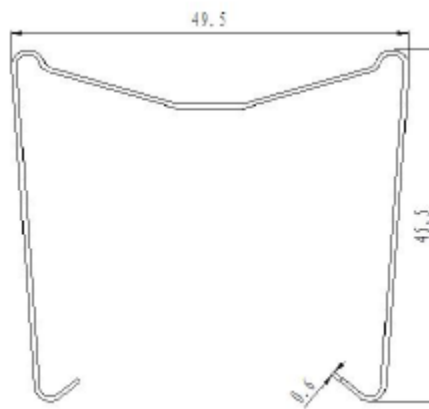

13. General Requirement

- 1) Compressor should be stored in a dry and drafty place.
- 2) Compressor should not be tilted or inverted in storage and transportation; collision should be avoided. The installation level and working condition should not be tilted at more than 5°.
- 3) Rubber plugs should not be pulled out from discharge tube before installation so as to avoid impurity and humidity. The installation should be completed within 10 minutes after that. (It is recommended to pull out the rubber plugs of discharge tube first.)
- 4) The compressor's ground connection should be reliably connected with that of the refrigeration appliance all the time.
- 5) In order to keep a pressure balance in system, the interval of operation should not be less than 5 minutes.
- 6) The charging volume of refrigerant oil has been optimized by our company. Do not pour any oil out or into the compressor randomly.
- 7) The accessories (ex. Starter, thermal protector etc.) are not installed during delivery, but can be found in the accessory case. Be sure to select the corresponding starter and the thermal protector models correspondingly.
- 8) Match the proper evaporating temperatures according to the low, middle, and high back pressure requirements. Pay attention to the admitted ranges of voltage and frequency for the different models.
- 9) Compressor cannot start or run in high-voltage or vacuum condition. Checking insulation and compressive resistance in vacuum is not allowed.
- 10) The process or suction tube of direct and semi-direct gas compressor cannot be inter changed, or it would be difficult to guarantee the performance of compressor.
- 11) Do not use the compressor as vacuum-pumping. The oxygen injection should not be used for leak detection of refrigeration system, or it would possibly cause accidents.
- 12) The oil return in system has been fully taken into consideration in design.
- 13) The ambient temperature in which compressor working should not be higher than 43 °C/113°F. The current and input power unit's continuous operation should not be exceeding the limitation of the compressor at the highest room temperature (43°C/113°F).
- 14) The stocking period must be less than 6 months after the date of production. If longer, you have to check whether the filled dry nitrogen is sufficient. Replenishment must be done if necessary.
- 15) Do not keep the R134a compressor connect pipe open too, ideally no longer than 10 minutes.
- 16) The vacuum pump and the charging system must only be dedicated to R134a.
- 17) The organic substance non-compatible with R134a cannot be used in the refrigeration system.
- 18) R134a refrigerating system should use the dry filter corresponding to R134a.
- 19) R134a refrigerant system should strictly control the content of moisture, impurities, paraffin, silicone oil and chloride ion.
- 20) R134a compressor is injected with Ester Oil approved by Hangzhou XinNihong Refrigeration Equipment Co. Ltd., it is not allowed to randomly pour out or add.

14. Environmental Protection Requirement to Compressor and Accessories

- 1) Requirement of PAHs: PAHs (II class): BaP content < 1 ppm, total content of 16 PAH (EPA) < 10 ppm
- 2) Regulatory requirement of REACH: SVHC < 1000 ppm
- 3) Requirement of Phthalate: total content of 18 hazardous material < 1000 ppm